



### Design: O/M

Surface luminaire with tubular shock-resistant clear polycarbonate diffuser and anti-condensation system comprising a valve that prevents condensation within the luminaire without affecting its high level of protection.

End caps in clear polycarbonate with marked installation angles.

Optic system with acrylic lens.

Equipped with 1m cable (H05RN-F) and a metallic cable gland.

Fitting accessories and IP68 connector supplied separately.

LED CRI>80 / >50.000h, L80/B10 / 3-step MacAdam

Power supply included.

IP67 | IK08 | 230Vac | 50/60Hz



LED	4000K	Light Source	Luminaire
Power		20W	24,4W
Flux		2745lm	2050lm
Efficiency		137lm/W	84lm/W
LOR		-	75%
UGR		-	<10

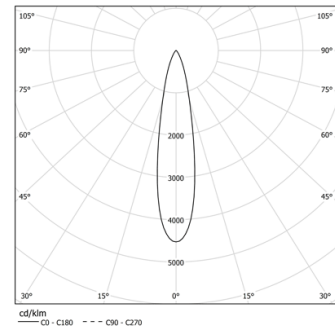

Beam angle  
Spot 21°

Application



Weight  
0,5Kg

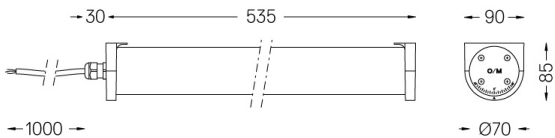

### Finishes

● .20 Clear

### Mandatory

43707 Surface fitting accessory

### Optional

43431 IP68 Connector

5 poles

For the specific supply of "DALI 2" drivers, please contact: support@om-light.com