

45+90W / 2300+4600lm / 4000K / DALI /  
Diffuse Direct/ Indirect / 2970mm

62400



Design: Eduardo Souto de Moura

Pendant luminaire with housing made of aluminium profile with 25micron maximum corrosion resistance anodization with textured electrostatic 100% polyester paint.

Frosted acrylic diffuser with user friendly clipping system.

Steel end caps with textured electrostatic 100% polyester paint.

Frosted acrylic diffuser for direct light and indirect light.

Fitting accessories ordered separately.

LED CRI>80 / >50.000h, L80/B10 / 3-step MacAdam

Power supply included.

IP20 | 230Vac | 50/60Hz



LED	4000K	Light Source	Luminaire
Power		45+90W	65+130W
Flux		5750+11500lm	2300+4600lm
Efficiency		128lm/W	35lm/W
LOR		-	40%
UGR		-	<25



Beam angle  
Diffuse Direct/  
Indirect

Application



Weight  
14Kg

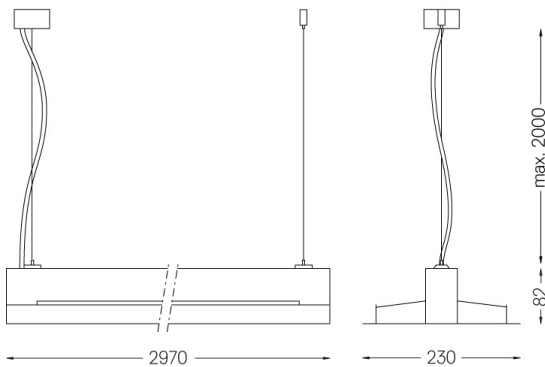

Finishes

- .01 White / RAL 9010
- .02 Black / RAL 9005
- .03 Grey / RAL 9006

Mandatory

56051 Clear base DALI

Ø60x35mm

54081 Aluminium base DALI

Ø60x37mm

For the specific supply of "DALI 2" drivers, please contact:  
support@om-light.com