

90W / 4600lm / 4000K / On/Off / Diffuse
indirect / 2970mm

62348



Design: Eduardo Souto de Moura
Pendant luminaire with housing made of aluminium profile with 25micron maximum corrosion resistance anodization with textured electrostatic 100% polyester paint.
Frosted acrylic diffuser with user friendly clipping system.
Steel end caps with textured electrostatic 100% polyester paint.
Frosted acrylic diffuser for direct light and indirect light.
Fitting accessories ordered Separately.

LED CRI>80 / >50.000h, L80/B10 / 3-step MacAdam
Power supply included.
IP20 | 230Vac | 50/60Hz



LED	4000K	Light Source	Luminaire
Power	90W	130W	
Flux	11500lm	4600lm	
Efficiency	128lm/W	35lm/W	
LOR	-	40%	
UGR	-	<25	



Beam angle
Diffuse indirect

Application



Weight
14Kg

mm

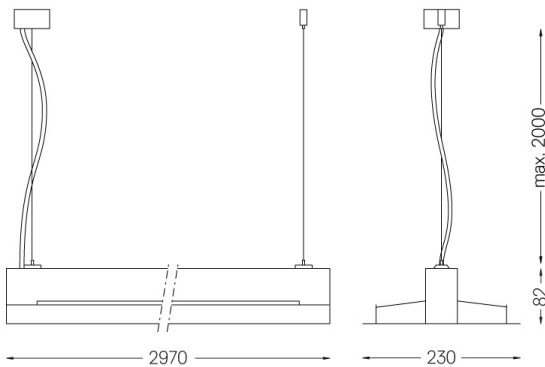

Finishes

- .01 White / RAL 9010
- .02 Black / RAL 9005
- .03 Grey / RAL 9006

Mandatory

- 54034 Clear base
Ø60x35mm
- 54080 Aluminium base
Ø60x37mm