

126W / 6600lm / 3000K / DALI / Diffuse
indirect / 2970mm

62345



Design: Eduardo Souto de Moura
Pendant luminaire with housing made of aluminium profile with 25micron maximum corrosion resistance anodization with textured electrostatic 100% polyester paint.
Frosted acrylic diffuser with user friendly clipping system.
Steel end caps with textured electrostatic 100% polyester paint.
Frosted acrylic diffuser for direct light and indirect light.
Fitting accessories ordered Separately.

LED CRI>80 / >50.000h, L80/B10 / 3-step MacAdam
Power supply included.
IP20 | 230Vac | 50/60Hz



LED	3000K	Light Source	Luminaire
Power	126W		180W
Flux	16400lm		6600lm
Efficiency	130lm/W		37lm/W
LOR	-		40%
UGR	-		<25



Beam angle
Diffuse indirect

Application



Weight
14Kg

mm

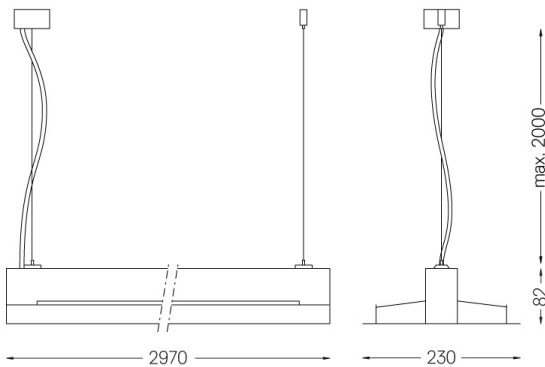

Finishes

- .01 White / RAL 9010
- .02 Black / RAL 9005
- .03 Grey / RAL 9006

Mandatory

- 56051 Clear base DALI
Ø60x35mm
- 54081 Aluminium base DALI
Ø60x37mm

For the specific supply of "DALI 2" drivers, please contact:
support@om-light.com