

90W / 4600lm / 3000K / DALI / Diffuse  
indirect / 2970mm

62344



Design: Eduardo Souto de Moura

Pendant luminaire with housing made of aluminium profile with 25micron maximum corrosion resistance anodization with textured electrostatic 100% polyester paint.

Frosted acrylic diffuser with user friendly clipping system.

Steel end caps with textured electrostatic 100% polyester paint.

Frosted acrylic diffuser for direct light and indirect light.

Fitting accessories ordered Separately.

LED CRI>80 / >50.000h, L80/B10 / 3-step MacAdam

Power supply included.

IP20 | 230Vac | 50/60Hz



LED 3000K	Light Source	Luminaire
Power	90W	130W
Flux	11500lm	4600lm
Efficiency	128lm/W	35lm/W
LOR	-	40%
UGR	-	<25



Beam angle  
Diffuse indirect

Application



Weight  
14Kg

mm

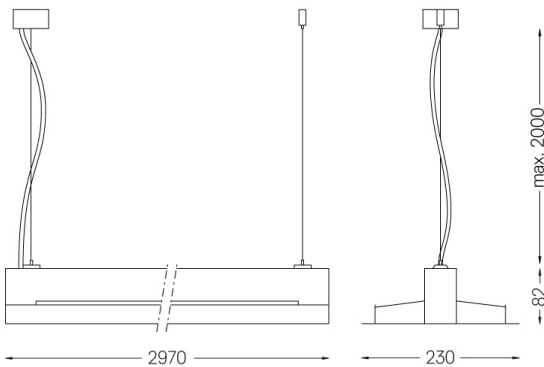

Finishes

- .01 White / RAL 9010
- .02 Black / RAL 9005
- .03 Grey / RAL 9006

Mandatory

56051 Clear base DALI

Ø60x35mm

54081 Aluminium base DALI

Ø60x37mm

For the specific supply of "DALI 2" drivers, please contact:  
support@om-light.com