

H45 Pendant

32+18W / 2840+1480lm / 4000K / DALI /
Diffuse / batwing / 2271mm

62212



Design: O/M

Pendant direct and indirect light luminaire with housing made of anodised aluminium profile with textured paint finish. Frosted diffuser for direct light and clear diffuser for indirect light with user friendly clipping system. 5mm aluminium end caps. Separate Circuits.

Suspension accessories available separately. Supply base made of aluminium, clear power cable (3x0,75mm²) and steel suspension cables (1,5mm) with millimetric height adjustment system.

LED CRI>80 / >50.000h, L80/B10 / 3-step MacAdam

Power supply included.

IP20 | 230Vac | 50/60Hz



LED	4000K	Light Source	Luminaire
Power		32+18W	39+20,7W
Flux		6040+2360lm	2840+1480lm
Efficiency		168lm/W	72lm/W
LOR		-	51%
UGR		-	<22

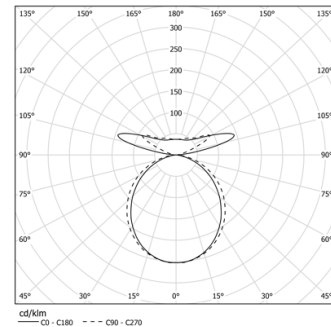

Beam angle
Diffuse / batwing

Application



Weight
7,9Kg

mm

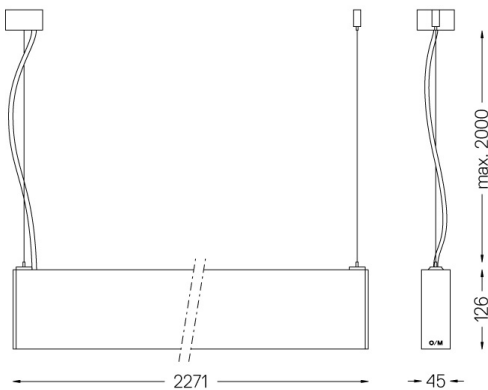

Finishes

- .01 White / RAL 9010
- .02 Black / RAL 9005
- .10 Anodised aluminium

Mandatory

56053 Pendant direct/indirect fitting accessory

56051 Clear base DALI

Ø60x35mm

For the specific supply of "DALI 2" drivers, please contact:
support@om-light.com

Data according to regulations

2019/2020/EU supplemented by 2021/341 | 2019/2015/EU supplemented by 2021/340/EU Energy Consumption Labelling Ordinance. This product contains light sources of efficiency class C and E

Model Identifier WU-M-594-840, 89603217