

## H45 Pendant

40+22W / 3550+1850lm / 4000K / On/Off /  
Diffuse / batwing / 2831mm

62206



Design: O/M

Pendant direct and indirect light luminaire with housing made of anodised aluminium profile with textured paint finish. Frosted diffuser for direct light and clear diffuser for indirect light with user friendly clipping system. 5mm aluminium end caps.

Separate Circuits.

Suspension accessories available separately. Supply base made of aluminium, clear power cable (3x0,75mm<sup>2</sup>) and steel suspension cables (1,5mm) with millimetric height adjustment system.

LED CRI>80 / >50.000h, L80/B10 / 3-step MacAdam

Power supply included.

IP20 | 230Vac | 50/60Hz



LED	4000K	Light Source	Luminaire
Power		40+22W	48,8+26,8W
Flux		7550+2950lm	3550+1850lm
Efficiency		169lm/W	71lm/W
LOR		-	51%
UGR		-	<22



Beam angle  
Diffuse / batwing

Application



Weight  
9,8Kg

mm

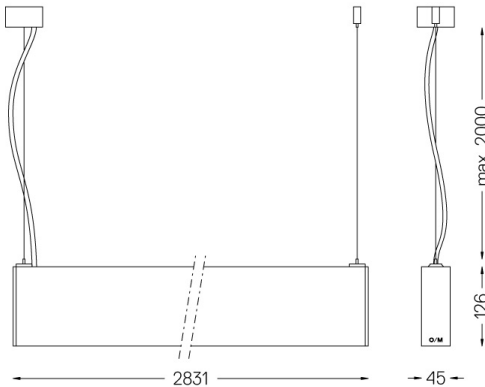

Finishes

- .01 White / RAL 9010
- .02 Black / RAL 9005
- .10 Anodised aluminium

Mandatory

56053 Pendant direct/indirect fitting accessory

54034 Clear base

Ø60x35mm

Data according to regulations

2019/2020/EU supplemented by 2021/341 | 2019/2015/EU supplemented by 2021/340/EU Energy Consumption Labelling Ordinance. This product contains light sources of efficiency class C and E

Model Identifier WU-M-594-840, 89603217