

52W / 3920lm / 3000K / On/Off / Flood 52°  
/ 1200mm

61280

Design: O/M + Bartenbach GmbH  
inVision module with housing and perforated cover plate made of aluminium with textured-paint finish.

LED CRI>90 / >50.000h, L80/B10 / 2-step MacAdam  
Power supply included.  
IP20 | 230Vac | 50/60Hz

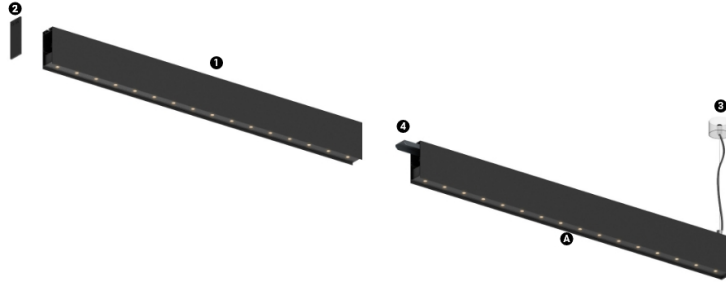

#### Structure

- 1 Profile
- 2 End caps
- 3 Fitting accessories
- 4 Profile coupling

#### Modules

- A inVision Module

LED	3000K	Light Source	Luminaire
Power		52W	61,2W
Flux		5160lm	3920lm
Efficiency		99lm/W	64lm/W
LOR		-	76%
UGR		-	<16

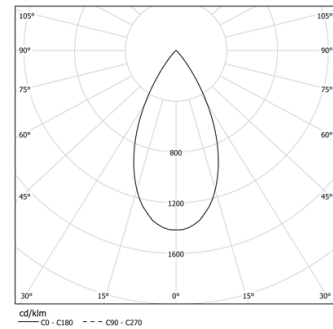

mm

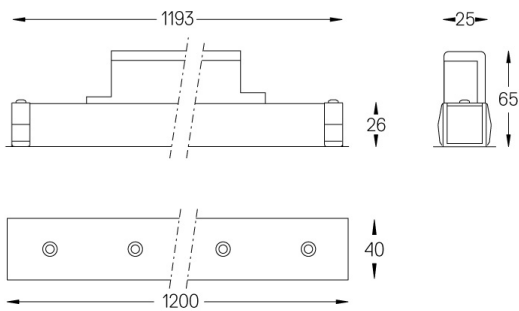

#### Finishes

- .01 White / RAL 9010
- .02 Black / RAL 9005

Choose the length and layout of the system exactly as you want it, to model the right lighting functions for different tasks. For further information please contact: [support@om-light.com](mailto:support@om-light.com)