

27W / 1840lm / 2700K / On/Off / Flood 52° / 1200mm

61263



Structure

- 1 Profile
- 2 End caps
- 3 Fitting accessories
- 4 Profile coupling

Modules

- A inVision Module

Design: O/M + Bartenbach GmbH
inVision module with housing and perforated cover plate made of aluminium with textured-paint finish.

LED CRI>90 / >50.000h, L80/B10 / 2-step MacAdam
Power supply included.
IP20 | 230Vac | 50/60Hz



LED	2700K	Light Source	Luminaire
Power		27W	32,9W
Flux		2400lm	1840lm
Efficiency		89lm/W	56lm/W
LOR		-	77%
UGR		-	<10

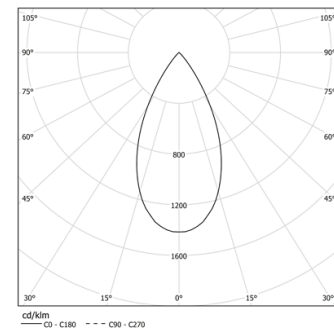

Beam angle
Flood 52°

Application



Weight
0,8Kg

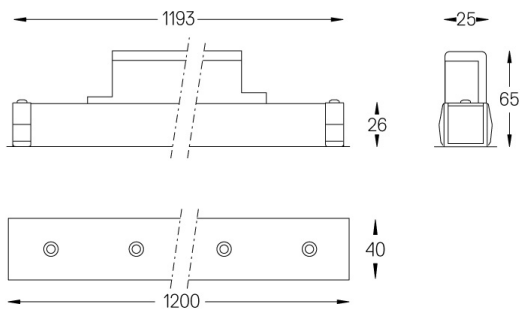

Finishes

- .01 White / RAL 9010
- .02 Black / RAL 9005

Choose the length and layout of the system exactly as you want it, to model the right lighting functions for different tasks. For further information please contact: support@om-light.com