

52W / 3480lm / 2700K / On/Off / Medium  
31° / 1200mm

61262



### Structure

- 1 Profile
- 2 End caps
- 3 Fitting accessories
- 4 Profile coupling

### Modules

- A inVision Module

Design: O/M + Bartenbach GmbH  
inVision module with housing and perforated cover plate made of aluminium with textured-paint finish.

LED CRI>90 / >50.000h, L80/B10 / 2-step MacAdam  
Power supply included.  
IP20 | 230Vac | 50/60Hz



LED	2700K	Light Source	Luminaire
Power		52W	61,2W
Flux		4800lm	3480lm
Efficiency		92lm/W	57lm/W
LOR		-	73%
UGR		-	<13

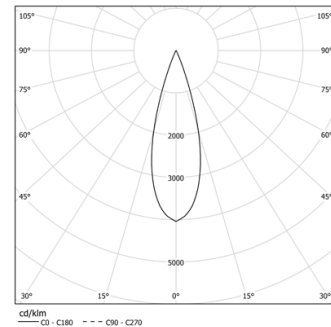

Beam angle  
Medium 31°

### Application



Weight  
0,8Kg

mm

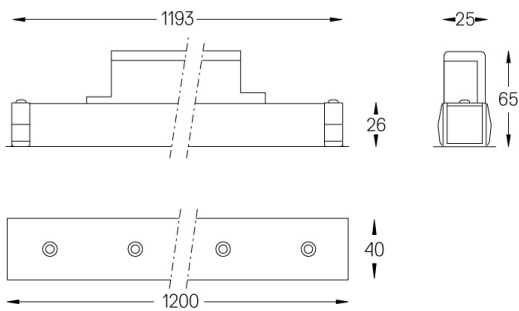

### Finishes

- .01 White / RAL 9010
- .02 Black / RAL 9005

Choose the length and layout of the system exactly as you want it, to model the right lighting functions for different tasks. For further information please contact: [support@om-light.com](mailto:support@om-light.com)