

52W / 5160lm / 4000K / DALI / Flood 52° /
1200mm

60981



Structure

- 1 Profile
- 2 End caps
- 3 Fitting accessories
- 4 Profile coupling

Modules

- A inVision Module

Design: O/M + Bartenbach GmbH
inVision module with housing and perforated cover plate made of aluminium with textured-paint finish.

LED CRI>80 / >50.000h, L80/B10 / 2-step MacAdam
Power supply included.
IP20 | 230Vac | 50/60Hz



LED	4000K	Light Source	Luminaire
Power		52W	61,2W
Flux		6800lm	5160lm
Efficiency		131lm/W	84lm/W
LOR		-	76%
UGR		-	<16

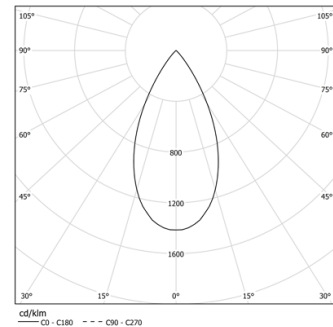

Beam angle
Flood 52°

Application



Weight
0,8Kg

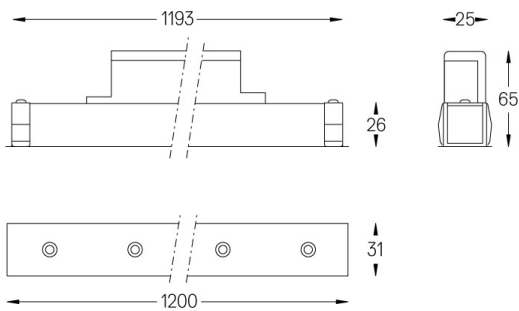

Finishes

- .01 White / RAL 9010
- .02 Black / RAL 9005

For the specific supply of "DALI 2" drivers, please contact:
support@om-light.com

Choose the length and layout of the system exactly as you want it, to model the right lighting functions for different tasks. For further information please contact: support@om-light.com