

27W / 2520lm / 4000K / DALI / Medium 31° / 1200mm

60978



Structure

- 1 Profile
- 2 End caps
- 3 Fitting accessories
- 4 Profile coupling

Modules

- A inVision Module

Design: O/M + Bartenbach GmbH

inVision module with housing and perforated cover plate made of aluminium with textured-paint finish.

LED CRI>80 / >50.000h, L80/B10 / 2-step MacAdam

Power supply included.

IP20 | 230Vac | 50/60Hz



LED	4000K	Light Source	Luminaire
Power		27W	32,9W
Flux		3440lm	2520lm
Efficiency		127lm/W	77lm/W
LOR		-	73%
UGR		-	<10

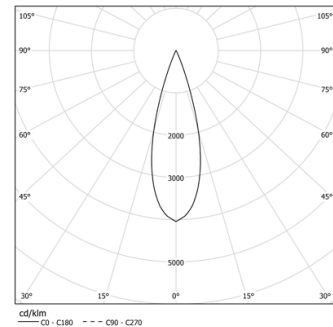

Beam angle
Medium 31°

Application



Weight
0,8Kg

mm

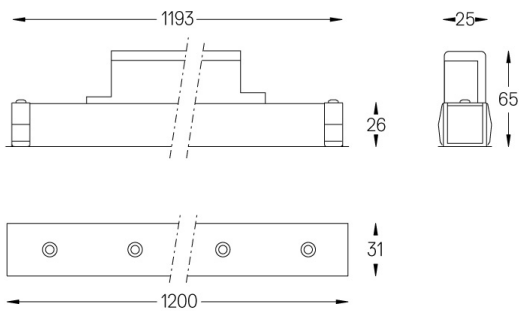

Finishes

- .01 White / RAL 9010
- .02 Black / RAL 9005

For the specific supply of "DALI 2" drivers, please contact: support@om-light.com

Choose the length and layout of the system exactly as you want it, to model the right lighting functions for different tasks. For further information please contact: support@om-light.com