

52W / 3640lm / 2700K / DALI / Flood 52° / 1200mm

60949



Structure

- 1 Profile
- 2 End caps
- 3 Fitting accessories
- 4 Profile coupling

Modules

- A inVision Module

Design: O/M + Bartenbach GmbH
inVision module with housing and perforated cover plate made of aluminium with textured-paint finish.

LED CRI>90 / >50.000h, L80/B10 / 2-step MacAdam
Power supply included.
IP20 | 230Vac | 50/60Hz



LED	2700K	Light Source	Luminaire
Power		52W	61,2W
Flux		4800lm	3640lm
Efficiency		92lm/W	59lm/W
LOR		-	76%
UGR		-	<16

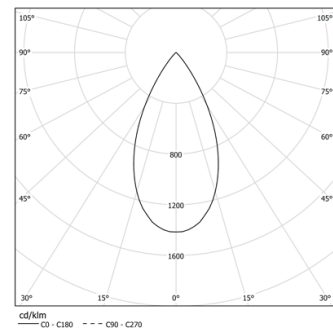

Beam angle
Flood 52°

Application



Weight
0,8Kg

mm

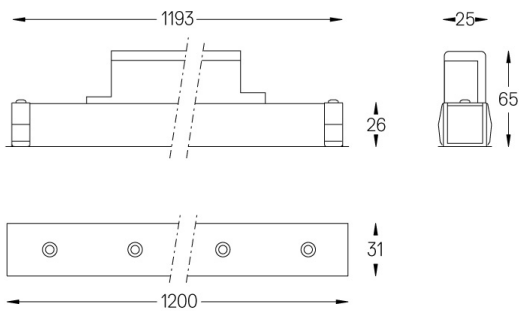

Finishes

- .01 White / RAL 9010
- .02 Black / RAL 9005

For the specific supply of "DALI 2" drivers, please contact:
support@om-light.com

Choose the length and layout of the system exactly as you want it, to model the right lighting functions for different tasks. For further information please contact: support@om-light.com