

14+28W / 1440+1360lm / 4000K / DALI /  
Wide flood 76° / batwing / 1192mm

60539



Design: OM + Bartenbach GmbH  
Pendant direct and indirect luminaire with housing made of aluminium in matte finish.  
Aluminium anodised end caps with matt finish.  
Linear lenses (Lightstream) combined with a secondary reflector, integrated into an extruded aluminium profile.  
Indirect light: Lenses for batwing effect protected by a transparent polycarbonate diffuser.  
Fitting accessories ordered separately.

LED CRI>90 / >50.000h, L80/B10 / 2-step MacAdam  
Power supply included.  
IP20 | 230Vac | 50/60Hz



LED	4000K	Light Source	Luminaire
Power		14+28W	16+32W
Flux		1800+1720lm	1440+1360lm
Efficiency		84lm/W	55lm/W
LOR		-	80%
UGR		-	<19

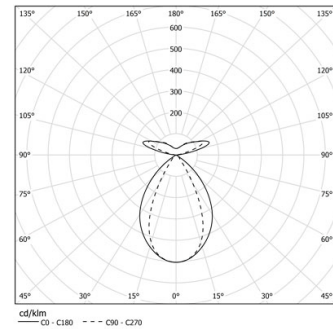

Beam angle  
Wide flood 76° /  
batwing

Application



Weight  
4,2Kg

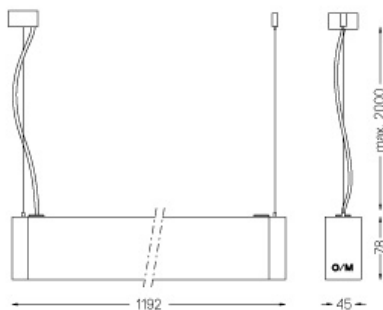

Finishes

- .04 Matt White
- .05 Matt Black

Mandatory

59054 Pendant direct/indirect fitting accessory

56051 Clear Base DALI

ø60x35mm

For the specific supply of "DALI 2" drivers, please contact:  
support@om-light.com