

27+56W / 2720+2560lm / 3000K / DALI /
Flood 64° / batwing / 2344mm

60534



Design: OM + Bartenbach GmbH
Pendant direct and indirect luminaire with housing made of aluminium in matte finish.
Aluminium anodised end caps with matt finish.
Linear lenses (Lightstream) combined with a secondary reflector, integrated into an extruded aluminium profile.
Indirect light: Lenses for batwing effect protected by a transparent polycarbonate diffuser.
Fitting accessories ordered separately.

LED CRI>90 / >50.000h, L80/B10 / 2-step MacAdam
Power supply included.
IP20 | 230Vac | 50/60Hz



LED	3000K	Light Source	Luminaire
Power		27+56W	32+64W
Flux		3360+3200lm	2720+2560lm
Efficiency		79lm/W	53lm/W
LOR		-	80%
UGR		-	<13

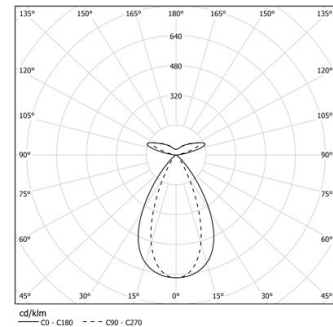

Beam angle
Flood 64° /
batwing

Application



Weight
8,2Kg

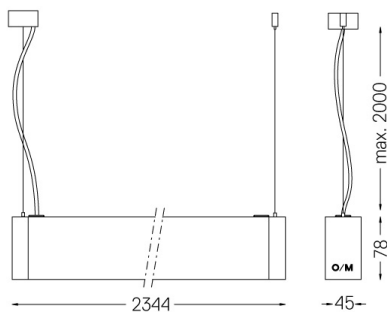

Finishes

- .04 Matt White
- .05 Matt Black

Mandatory

59054 Pendant direct/indirect fitting accessory

56051 Clear Base DALI

ø60x35mm

For the specific supply of "DALI 2" drivers, please contact:
support@om-light.com