

10W / 860lm / 4000K / DALI / Diffuse /  
ø100mm

60468



Design: O/M

Ceiling-recessed luminaire made of aluminium die-cast.

Recessing accessory for flush version supplied separately.

LED CRI>80 / >50.000h, L80/B10  
3-step MacAdam / power supply included  
IP54 | 230Vac | 50/60Hz



LED	4000K	Light Source	Luminaire
Power	10W		12,5W
Flux	1450lm		860lm
Efficiency	145lm/W		69lm/W
LOR	-		59%
UGR	-		<28



Beam angle  
Diffuse

Application



Weight  
0,5Kg



∅95 (trim version)

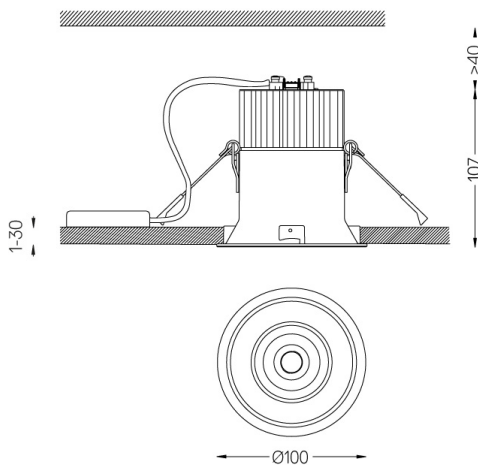

Finishes

- .04 Matt White
- .05 Matt Black

Optional

- 59066** Flush accessory (12.5mm ceilings)  
201x17mm
- 59067** Flush accessory (15mm ceilings)  
201x19,5mm
- 59068** Flush accessory (25mm ceilings)  
201x29,5mm

For the specific supply of "DALI 2" drivers, please contact:  
support@om-light.com

The cutout dimensions are for plasterboard ceilings. For other type of material please contact: support@om-light.com

Data according to regulations

2019/2020/EU supplemented by 2021/341 | 2019/2015/EU supplemented by 2021/340/EU Energy Consumption Labelling Ordinance. This product contains a light source of efficiency class E Model Identifier BXRC-40E2000-C-89

## Beam IP54

Flush accessory (12.5mm  
ceilings)

59066



Ø112



Flush accessory Beam ø100  
For 12.5mm ceilings.

Weight  
0,05Kg

Finishes  
.99

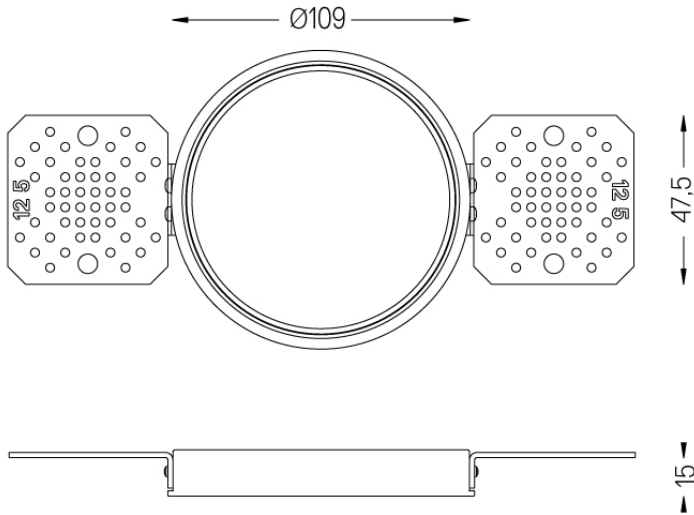

## Beam IP54

Flush accessory (15mm  
ceilings)

59067

1 mm

Ø112



Flush accessory Beam  $\varnothing$ 100  
For 15mm ceilings.

Weight  
0,05Kg

Finishes  
.99

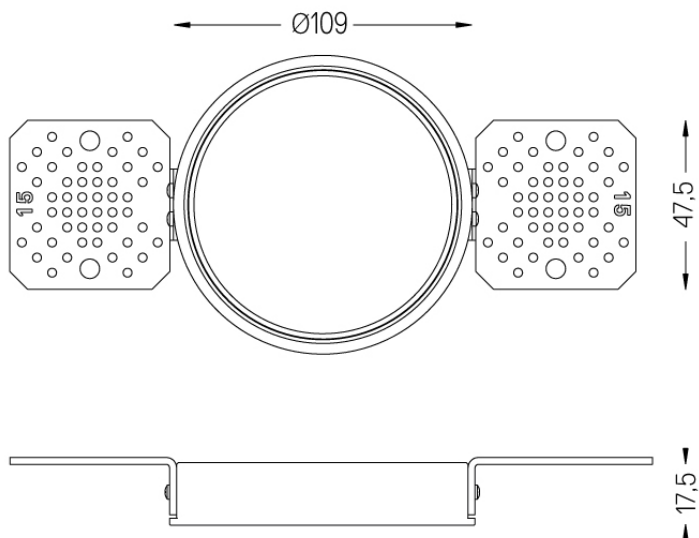

## Beam IP54

Flush accessory (25mm  
ceilings)

59068

mm

Ø112



Flush accessory Beam  $\varnothing$ 100  
For 25mm ceilings.

Weight  
0,05Kg

Finishes  
.99

