

Beam IP54

2,2W / 170lm / 2700K / DALI / Spot 14° /
ø75mm

60399



Design: O/M

Ceiling-recessed luminaire made of aluminium die-cast.

Recessing accessory for flush version supplied separately.

LED CRI>90 / >50.000h, L80/B10
2-step MacAdam / power supply included
IP54 | 230Vac | 50/60Hz



LED	2700K	Light Source	Luminaire
Power	2,2W		2,8W
Flux	200lm		170lm
Efficiency	91lm/W		60lm/W
LOR	-		85%
UGR	-		<10



Beam angle
Spot 14°

Application



Weight
0,38Kg



Ø70 (trim version)

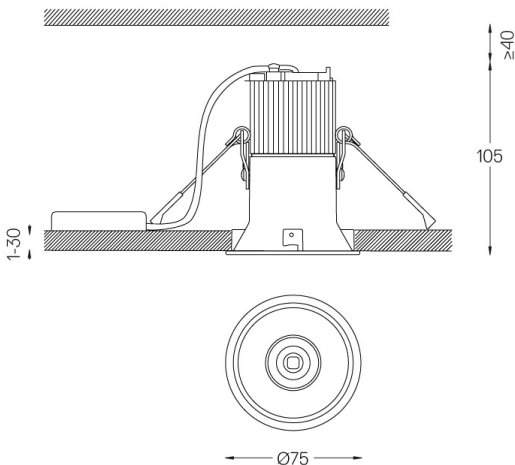

Finishes

- .04 Matt White
- .05 Matt Black

Optional

- 59063** Flush accessory (12.5mm ceilings)
176x17mm
- 59064** Flush accessory (15mm ceilings)
176x19,5mm
- 59065** Flush accessory (25mm ceilings)
176x29,5mm

For the specific supply of "DALI 2" drivers, please contact:
support@om-light.com

The cutout dimensions are for plasterboard ceilings. For other type of material please contact: support@om-light.com

Data according to regulations

2019/2020/EU supplemented by 2021/341 | 2019/2015/EU supplemented by 2021/340/EU Energy Consumption Labelling Ordinance. This product contains a light source of efficiency class F Model Identifier 4053560279