

Beam

19W / 1720lm / 3000K / DALI / Flood 46° /
 ø100mm

60377



Design: O/M

Ceiling-recessed luminaire made of aluminium die-cast.

Recessing accessory for flush version supplied separately.

LED CRI>80 / >50.000h, L80/B10
 3-step MacAdam / Power supply included.
 IP20 | 230Vac | 50/60Hz



LED	3000K	Light Source	Luminaire
Power	19W	23,2W	
Flux	2180lm	1720lm	
Efficiency	115lm/W	74lm/W	
LOR	-	79%	
UGR	-	<22	



Beam angle
Flood 46°

Application



Weight
0,5Kg

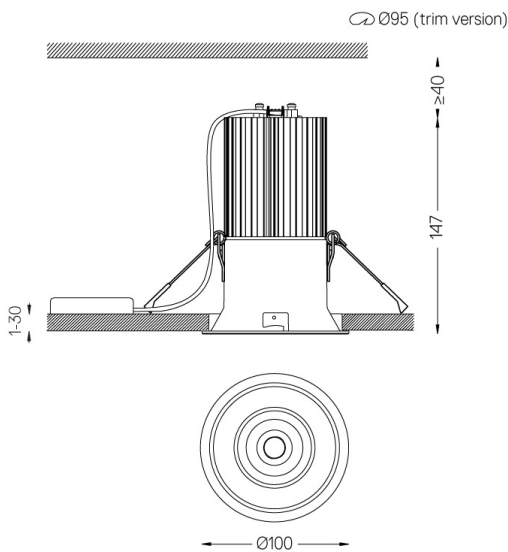

Finishes

- .04 Matt White
- .05 Matt Black

Optional

- 59066** Flush accessory (12.5mm ceilings)
201x17mm
- 59067** Flush accessory (15mm ceilings)
201x19,5mm
- 59068** Flush accessory (25mm ceilings)
201x29,5mm

For the specific supply of "DALI 2" drivers, please contact:
support@om-light.com

The cutout dimensions are for plasterboard ceilings. For other type of material please contact: support@om-light.com

Data according to regulations

2019/2020/EU supplemented by 2021/341 | 2019/2015/EU supplemented by 2021/340/EU Energy Consumption Labelling Ordinance. This product contains a light source of efficiency class E Model Identifier BXRC-30E2000-C-73