

Beam

10W / 700lm / 2700K / On/Off / Medium 23°
/ ø75mm

60328



Design: O/M

Ceiling-recessed luminaire made of aluminium die-cast.

Recessing accessory for flush version supplied separately.

LED CRI>90 / >50.000h, L80/B10
2-step MacAdam / Power supply included.
IP20 | 230Vac | 50/60Hz



LED	2700K	Light Source	Luminaire
Power	10W		12,5W
Flux	955lm		700lm
Efficiency	96lm/W		56lm/W
LOR	-		73%
UGR	-		<19



Beam angle
Medium 23°

Application



Weight
0,38Kg



Ø70 (trim version)

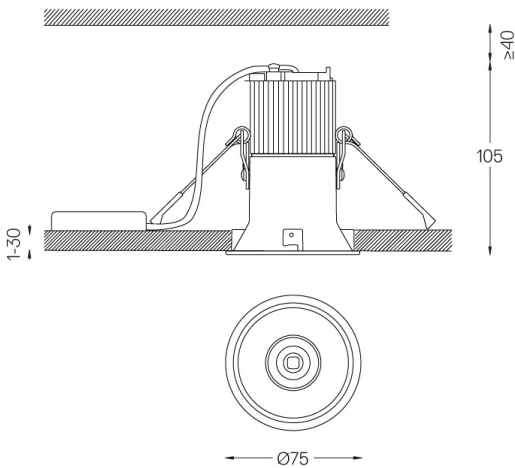

Finishes

- .04 Matt White
- .05 Matt Black

Optional

- 59063** Flush accessory (12.5mm ceilings)
176x17mm
- 59064** Flush accessory (15mm ceilings)
176x19,5mm
- 59065** Flush accessory (25mm ceilings)
176x29,5mm

The cutout dimensions are for plasterboard ceilings. For other type of material please contact: support@om-light.com

Data according to regulations

2019/2020/EU supplemented by 2021/341 | 2019/2015/EU
supplemented by 2021/340/EU Energy Consumption Labelling
Ordinance. This product contains a light source of efficiency class F
Model Identifier 2053560245H