

9,8W / 1110lm / 4000K / On/Off / Flood 56° / ø85mm

60219



Design: O/M + Bartenbach GmbH

Ceiling-recessed luminaire with aluminium die-cast body and heat sink with electrostatic 100% polyester paint finish.

Lightcore optics for defined and perfectly controlled beam of light.

Easy recessing system with spring clips.

Fitting accessories for different applications are available.

LED CRI>80 / >50.000h, L80/B10  
2-step MacAdam / Power supply included.  
IP65 | 230Vac | 50/60Hz



LED	4000K	Light Source	Luminaire
Power		9,8W	12,3W
Flux		1360lm	1110lm
Efficiency		139lm/W	91lm/W
LOR		-	82%
UGR		-	<19



Beam angle  
Flood 56°

Application



Weight  
0,53Kg



Ø78 (trim version)

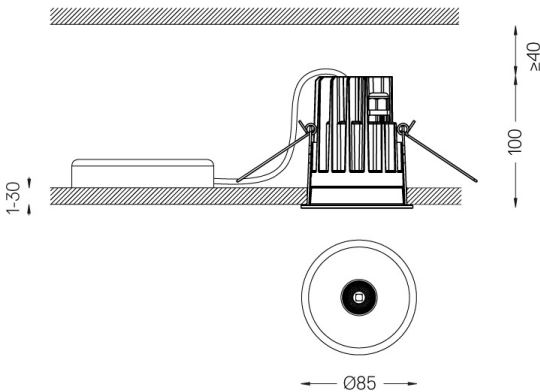

Finishes

- .01 White / RAL 9010
- .02 Black / RAL 9005

Optional

**59014** Accessory 12,5mm ceilings (flush installation)

150x91x20mm

**59038** Accessory 10-40mm ceilings (acoustic ceiling)

156x100x78mm

The cutout dimensions are for plasterboard ceilings. For other type of material please contact: support@om-light.com

Data according to regulations

2019/2020/EU supplemented by 2021/341 | 2019/2015/EU supplemented by 2021/340/EU Energy Consumption Labelling Ordinance. This product contains a light source of efficiency class F Model Identifier 2053560247H