

9,8W / 860lm / 2700K / DALI / Flood 56° / ø85mm

60143



Design: O/M + Bartenbach GmbH

Ceiling-recessed luminaire with aluminium die-cast body and heat sink with electrostatic 100% polyester paint finish.

Lightcore optics for defined and perfectly controlled beam of light.

Easy recessing system with spring clips.

Fitting accessories for different applications are available.

LED CRI>90 / >50.000h, L80/B10
2-step MacAdam / Power supply included.
IP20 | 230Vac | 50/60Hz



LED	2700K	Light Source	Luminaire
Power	9,8W		12,3W
Flux	955lm		860lm
Efficiency	97lm/W		70lm/W
LOR	-		90%
UGR	-		<19

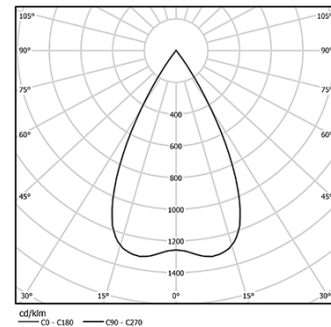

Beam angle
Flood 56°

Application



Weight
0,53Kg



Ø78 (trim version)

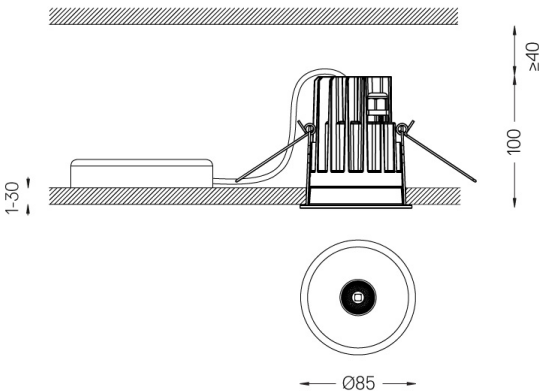

Finishes

- .01 White / RAL 9010
- .02 Black / RAL 9005

Optional

59014 Accessory 12,5mm ceilings (flush installation)

150x91x20mm

59038 Accessory 10-40mm ceilings (acoustic ceiling)

156x100x78mm

For the specific supply of "DALI 2" drivers, please contact:
support@om-light.com

The cutout dimensions are for plasterboard ceilings. For other type of material please contact: support@om-light.com

Data according to regulations

2019/2020/EU supplemented by 2021/341 | 2019/2015/EU supplemented by 2021/340/EU Energy Consumption Labelling Ordinance. This product contains a light source of efficiency class F Model Identifier 2053560245H