

U2

Design: Eduardo Souto de Moura

An elegant profile great for work environments, galleries, and other human spaces, the U2 projects to the ceiling to create ambience in any curated interior. The U2's classic design also removes glare while offering great light and unlimited extensibility.

Profile

Aluminium double profile with 25 micron maximum corrosion resistance anodisation with matt finish or electrostatic 100% polyester paint with textured-finish suitable for adverse climate conditions. Aluminium profile connector with textured paint finish.

Diffuser

Frosted (LED version) or clear (T5 version) polycarbonate diffusers with user friendly clipping system.

End caps

Aluminium anodised end caps with matt finish or electrostatic 100% polyester paint with textured-finish suitable for adverse climate conditions.

Modules

High-efficiency LED modules up to 150lm/W, with excellent colour consistency (3 step-MacAdam) and long lifespan (>50.000h; L80/B10). Fluorescent modules with T5 in-line lamps, multiwatt ballast and internal aluminium reflector with 98% reflection included.

Fitting accessories

Suspension fittings accessories include power supply base and 2m suspension cables. Power supply base made of clear polycarbonate and supplied with clear power cable. 1.5 mm steel suspension cables with millimetric height adjustment system. When configuring the system, the power supply base can also be supplied in aluminium with matt finish or white or black textured paint. The power cable will have the same colour of the painted version (white or black) or clear for matt version.



U2 Sys Planning

This system is easy to configure and can be planned in just a few steps.

1

Components. Check all the components you need.

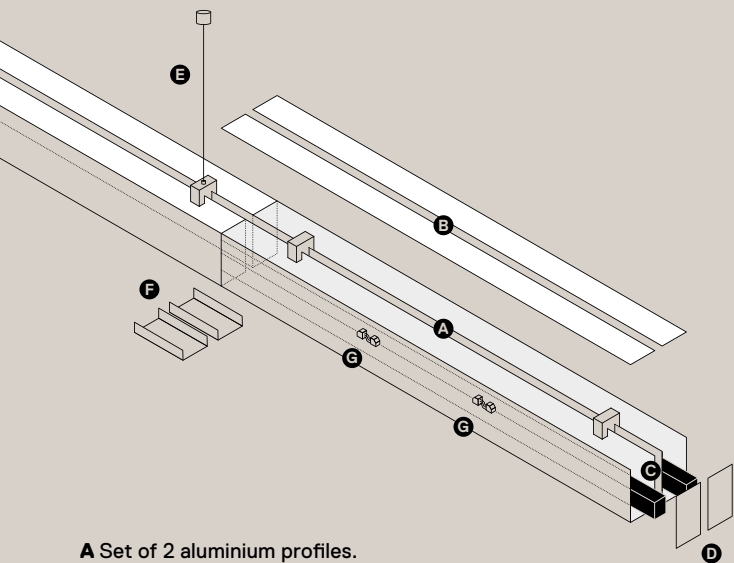

A Set of 2 aluminium profiles.

B Set of 2 polycarbonate diffusers.

C Light source modules available with different sizes and characteristics. Available in LED and T5 with in-line lamps.

D Set of 2 end caps for each end of the line.

E Set of suspension accessories.

F Set of concealed connections between profiles.

G Set of module connectors for a safe and easy electrical connection.

2

Light Source Modules.

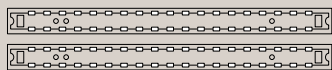

High-efficiency LED modules up to 150lm/W, excellent linearity and uniformity of light.

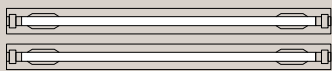

T5 fluorescent modules with internal aluminium reflector with 98% reflection included.

3

Measure, calculate and design the luminaire.

Use the formula indicated below to determine which modules best match your requirements. You will find all the lengths available on the modules page.

Pendant indirect



LED

$M + 110\text{mm}$



T5

$M + 110\text{mm}$

M Sum of the lengths of the light source modules.

4

Choose the finish.

To select the required finish, add the finish code to the end of the profile, end caps and power supply base code.

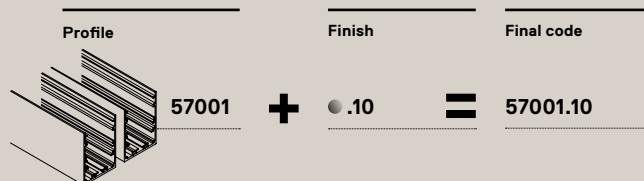

U2 Sys Ordering

Select the codes of the various components.

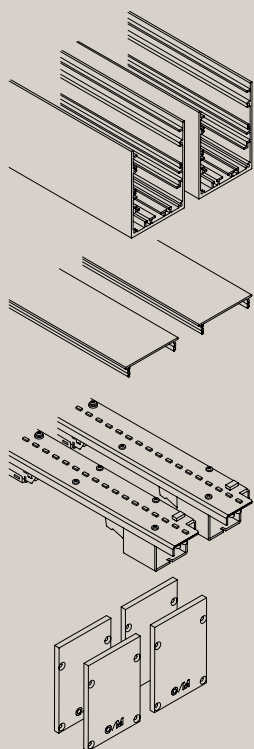

Pendant indirect



Double profile

Unit=1m

57001

Aluminium



Double diffuser

Unit=1m

57099

LED Frost

57002

T5 Clear

Double module

LED and T5

pag. 266

End cap

Set of four

57004

Aluminium



Fitting accessories

57043

One 2m steel cables (1,5mm)
(max. interval 3m)

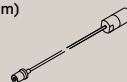

54034 On/Off (3x0,75mm²)

56051 DALI or E-KIT (5x0,75mm²)

One clear power supply base must
be applied every 30m (Ø60x35mm).



54080 On/Off (3x0,75mm²)

54081 DALI or E-KIT (5x0,75mm²)

One aluminium power supply base must
be applied every 30m (Ø60x37mm).



54082 DALI and E-KIT (7x0,75mm²)

One aluminium power supply base must
be applied every 30m (Ø60x52mm).



Connectors

Module connector (set of two)

57040 On/Off

57097 DALI

57098 E-KIT

57042 DALI and E-KIT

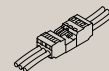

Profile coupling (set of two)

57044

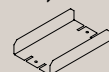

Finishes

Max. length 3m:

● .01 White

● .02 Black

● .00 RAL on request

Max. length 6m:

● .10 Anodised aluminium

U2 Sys

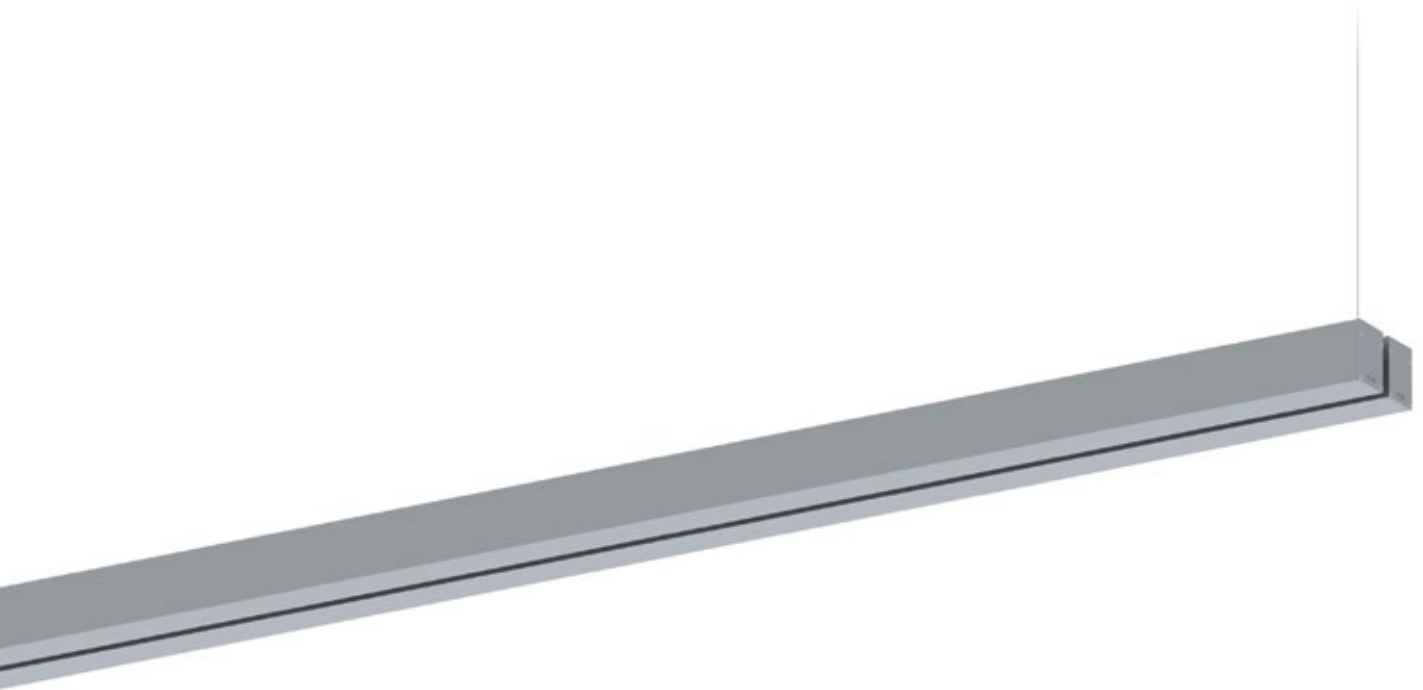
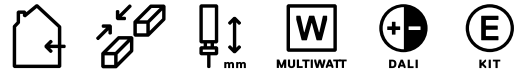

This system is a versatile solution for creating a customised luminaire.

The flexibility of this product is reflected in the possibility of choosing different lengths.

LED CRI>80 / >50.000h, L80/B10 / 3-step MacAdam

Power supply included.

T5 multiwatt ballast and internal aluminium reflector with 98% reflection included.



IP20 | 230Vac | 50/60Hz



U2 Pendant indirect

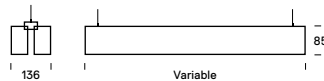

	Light Source Power	Light Source Flux	Luminaire Flux	On/Off Code	DALI Code	On/Off + E-KIT Code	DALI + E-KIT Code
--	--------------------	-------------------	----------------	-------------	-----------	---------------------	-------------------

U2 Sys Modules



LED

Low Output

3000K

1162mm	32W	4600lm	2200lm	57045	57055	-	-
1742mm	48W	7000lm	3400lm	57047	57057	57065	57069
2322mm	64W	9400lm	4400lm	57049	57059	57067	57071
2902mm	80W	11650lm	5600lm	57051	57061	-	-
3482mm	96W	14000lm	6800lm	57053	57063	-	-

4000K

1162mm	32W	5000lm	2400lm	57046	57056	-	-
1742mm	48W	7500lm	3600lm	57048	57058	57066	57070
2322mm	64W	10000lm	4800lm	57050	57060	57068	57072
2902mm	80W	12500lm	6000lm	57052	57062	-	-
3482mm	96W	15000lm	7200lm	57054	57064	-	-

High Output

3000K

561mm	28W	4200lm	2200lm	57073	57083	-	-
841mm	43W	6300lm	3200lm	57075	57085	-	-
1123mm	58W	8400lm	4300lm	57077	57087	-	-
1403mm	72W	10500lm	5500lm	57079	57089	-	-
1685mm	87W	12600lm	7400lm	57081	57091	57093	57095

4000K

561mm	28W	4300lm	2300lm	57074	57084	-	-
841mm	43W	6600lm	3350lm	57076	57086	-	-
1123mm	58W	8800lm	4500lm	57078	57088	-	-
1403mm	72W	11000lm	5700lm	57080	57090	-	-
1685mm	87W	13200lm	7750lm	57082	57092	57094	57096



T5

573mm	2x(1x14/24W)	-	-	57005	-	-	-
873mm	2x(1x21/39W)	-	-	57006	57007	-	-
1173mm	2x(1x28/54W)	-	-	57010	57011	57012	57013
1473mm	2x(1x35/49W)	-	-	57017	57018	57019	57020
1146mm	2x(2x14/24W)	-	-	57021	57022	-	-
1746mm	2x(2x21/39W)	-	-	57023	57024	57025	57026
2346mm	2x(2x28/54W)	-	-	57029	57030	57031	57032
2946mm	2x(2x35/49W)	-	-	57036	57037	57038	57039